

# DOCUMENTACIÓN TÉCNICA

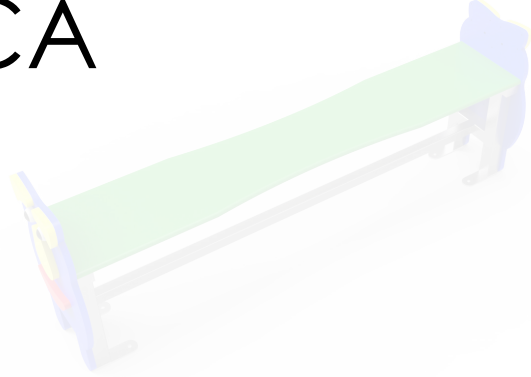

Ref.: CGD05

Conjunto Guardería  
"Banco Don Cuco"

UNE EN 1176-1:2018

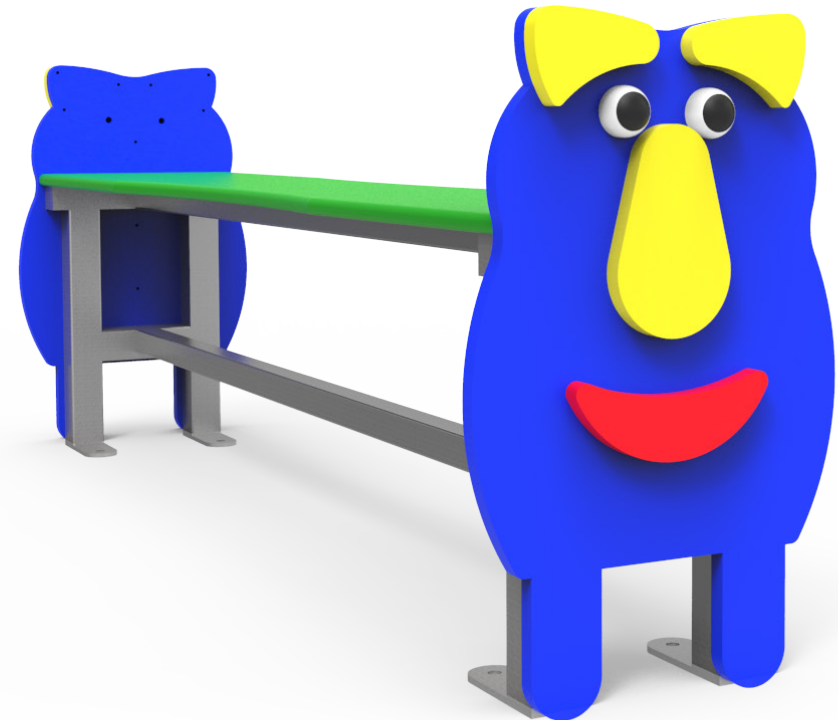

Altura libre de caída: 0,35 m

Edad recomendada de uso: de 0 a 3 años

Componentes plásticos: Polietileno de alta densidad con protección UV

Estructura metálica galvanizada

Tornillería protegida con tapones de polipropileno

ALZADO

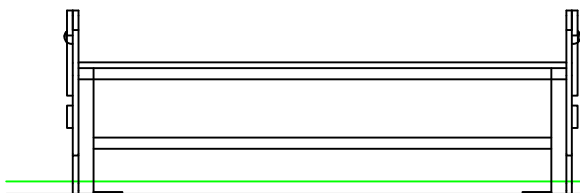

PERFIL IZQUIERDO

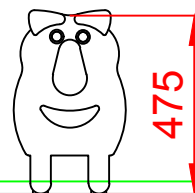

PLANTA

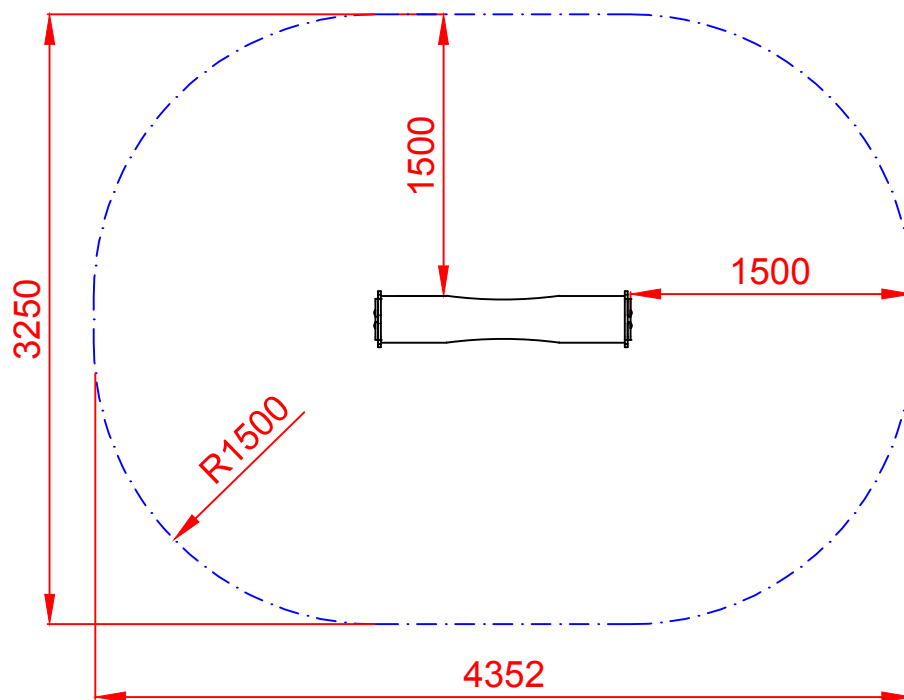
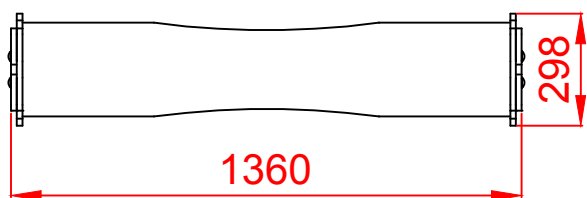

ÁREA DE SEGURIDAD  
Superficie= 12,24m<sup>2</sup>  
E: 1/2

Dibujado		PLANO 1 VISTAS GENERALES		Ref:	CGD05
Revisado					
Aprobado					
Descripción:		ESCALA:	Nº Hoja		
CONJUNTO GUARDERÍA "BANCO DON CUCO"			2/4		
		Fecha:	29/07/2019		



# DETALLES CIMENTACIÓN

## ESQUEMA DE CIMENTACIÓN EN ARENA

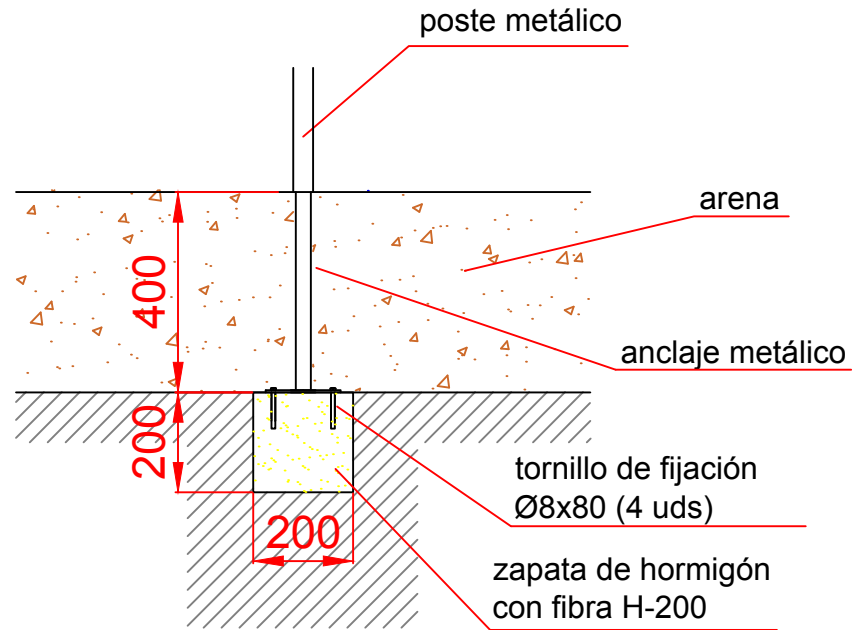

## ESQUEMA DE CIMENTACIÓN EN HORMIGÓN

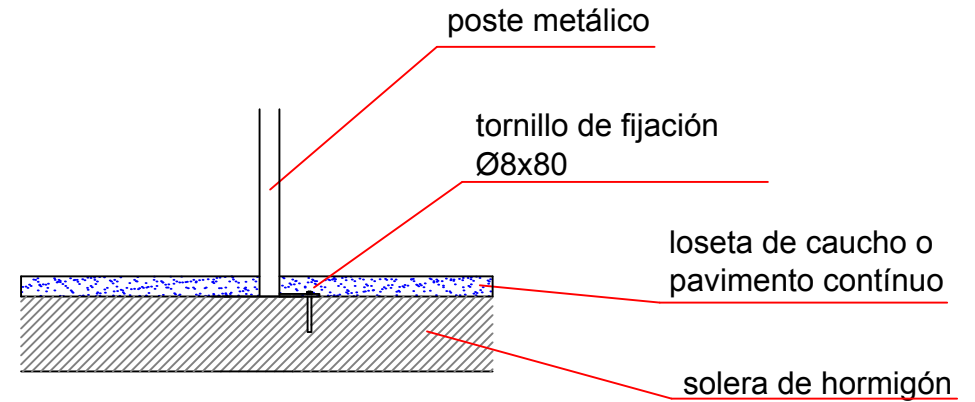

## PLANTA CIMENTACIÓN

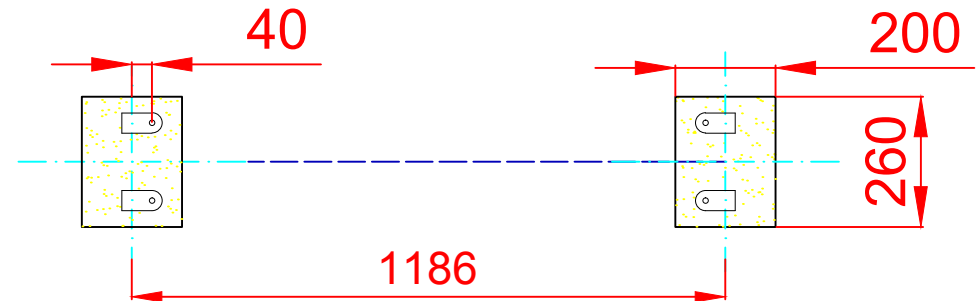

Dibujado		PLANO 2 CIMENTACIÓN Y ANCLAJES	Ref:	CGD05
Revisado				
Aprobado				
Descripción:		Escala:	Nº Hoja	3/4
CONJUNTO GUARDERÍA "BANCO DON CUCO"		Fecha:	29/07/2019	

ALZADO

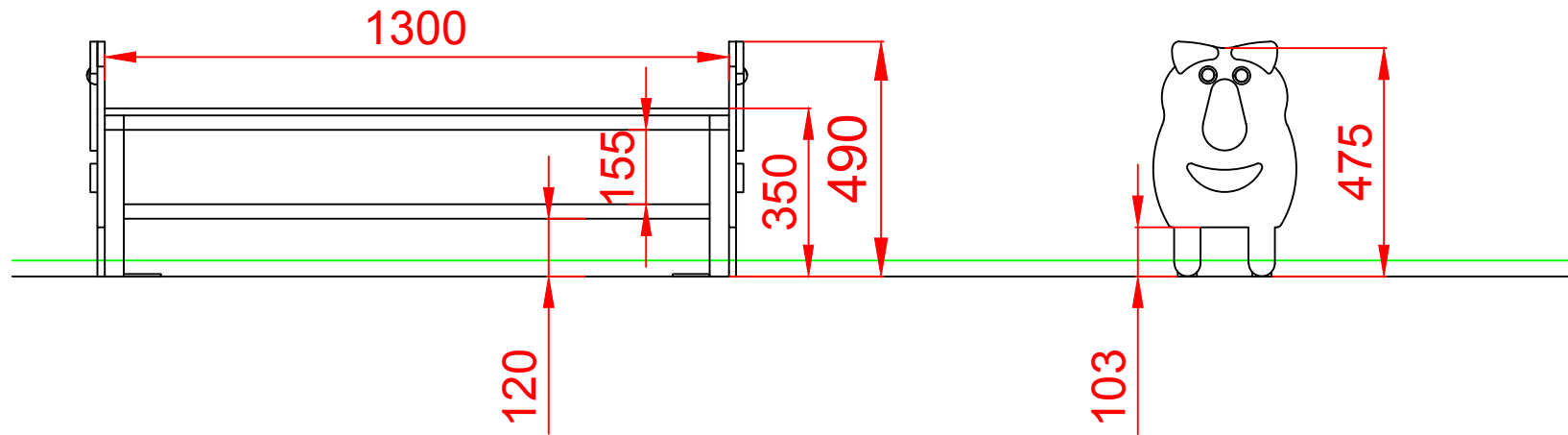

PERFIL IZQUIERDO

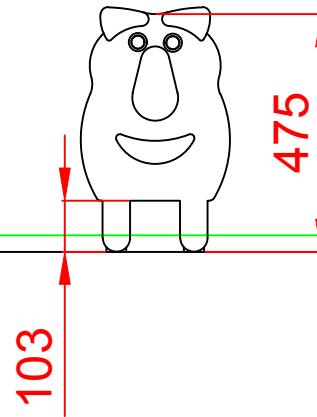

PLANTA

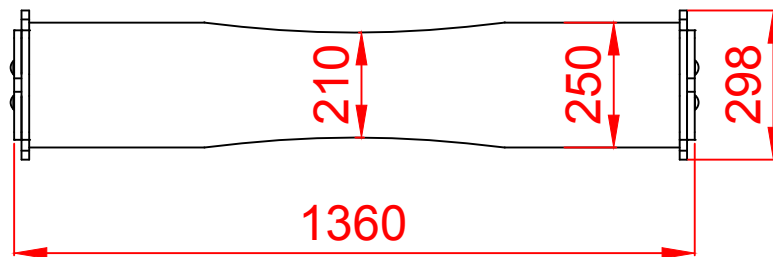

Dibujado		PLANO 3 VISTAS DE DETALLE		Ref: CGD05
Revisado				
Aprobado				
Descripción:		Escala:	Nº Hoja	
CONJUNTO GUARDERÍA "BANCO DON CUCO"			4/4	
		Fecha:	29/07/2019	