

DOCUMENTACIÓN TÉCNICA



Ref.: COM03

Tirolina (20 y 35 m)

UNE EN 1176-1:2018

UNE EN 1176-4:2018



Altura libre de caída: 1 m

Edad recomendada de uso: a partir de 5 años

Componentes plásticos: Polietileno de alta densidad con protección UV

Componentes metálicos galvanizados

Tornillería protegida con tapones de polietileno

ALZADO

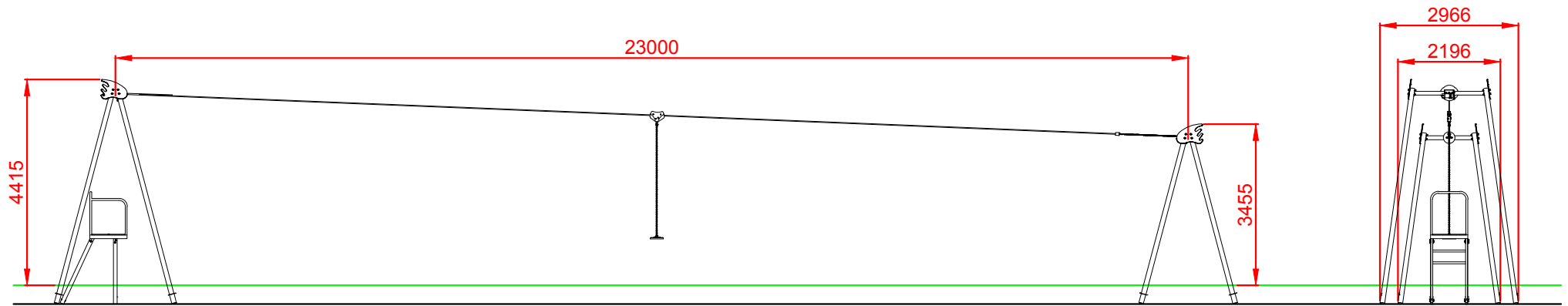

PLANTA

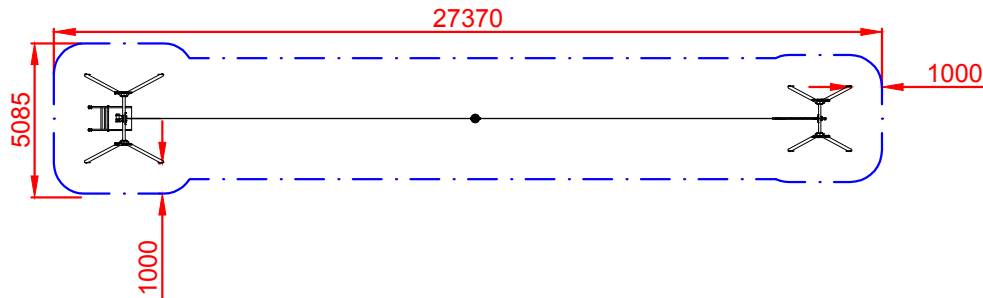
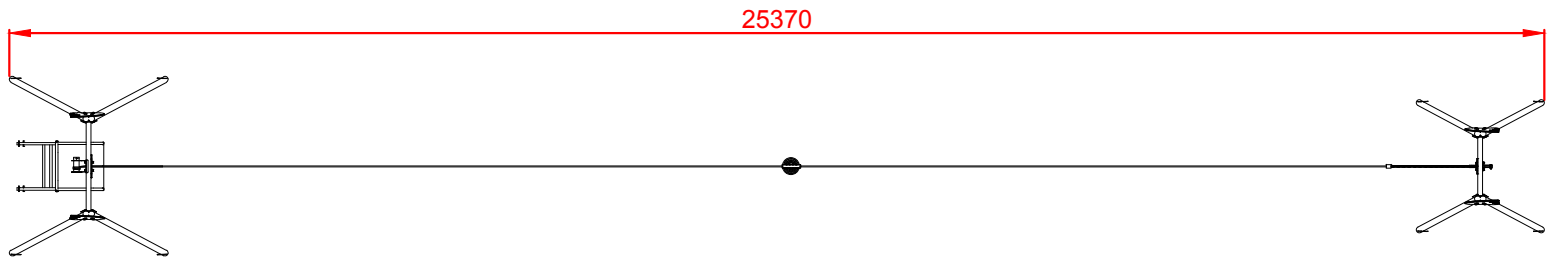

ÁREA DE SEGURIDAD
 SUPERFICIE= 113,32 m²
 E: 1/2

Dibujado		PLANO 1 VISTAS GENERALES		Ref: COM03
Revisado				
Aprobado		Descripción: TIROLINA (23 METROS)	Escala: N° Hoja 2/4	
		Fecha: 18-05-21		

PLANTA CIMENTACIÓN

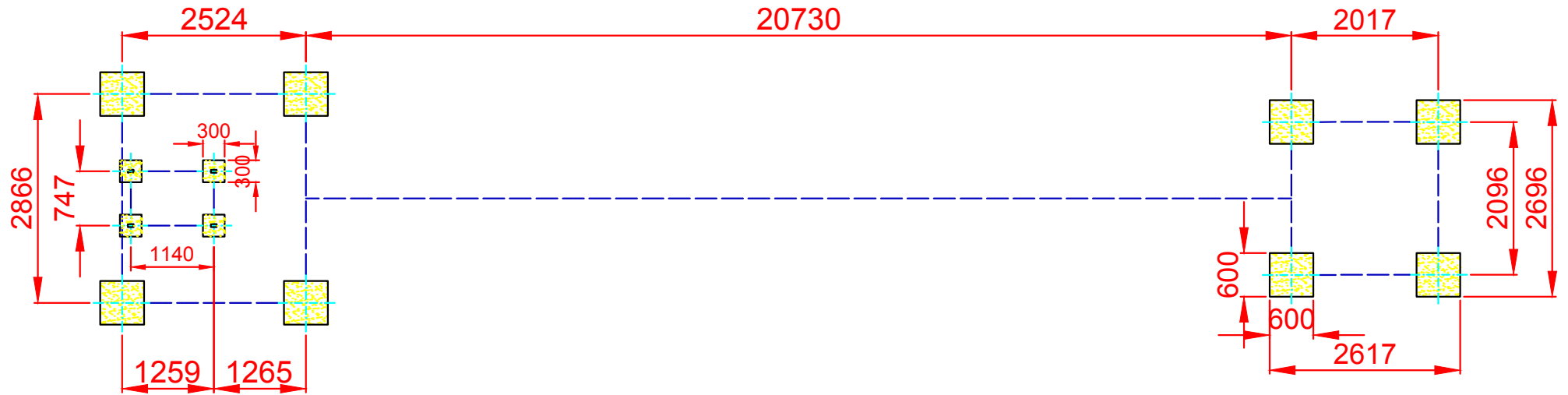

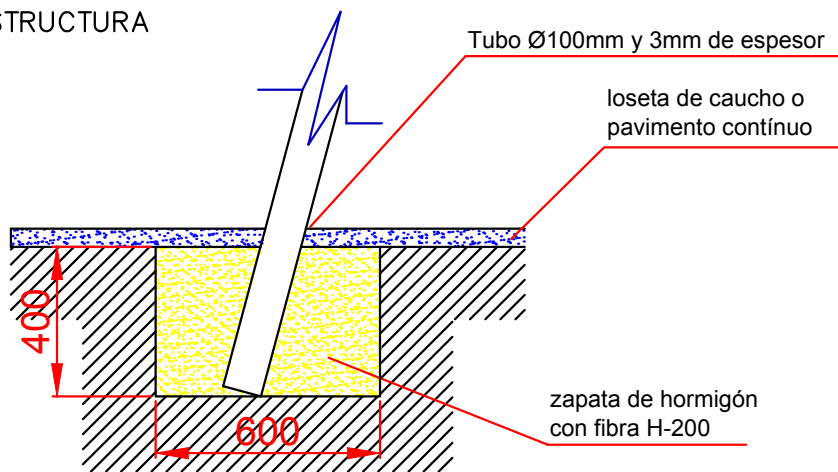

DETALLES DE CIMENTACIÓN

ESTRUCTURA

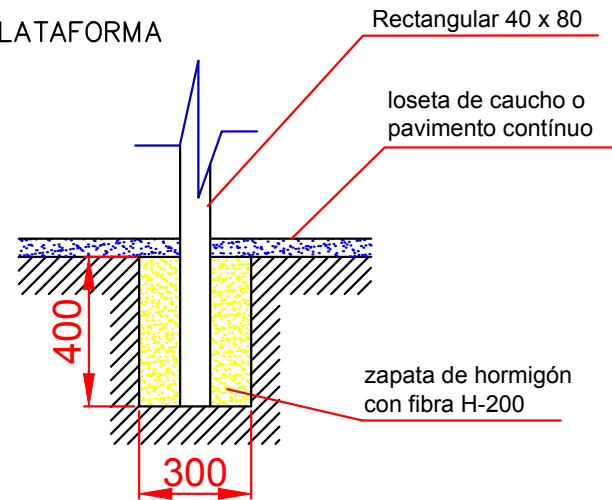

PLATAFORMA



Dibujado		PLANO 2 CIMENTACIÓN Y ANCLAJES	Ref:	COM03
Revisado				
Aprobado				
Descripción:		TIROLINA (23 METROS)	Escala:	Nº Hoja 3/4
			Fecha:	18-05-21

ALZADO

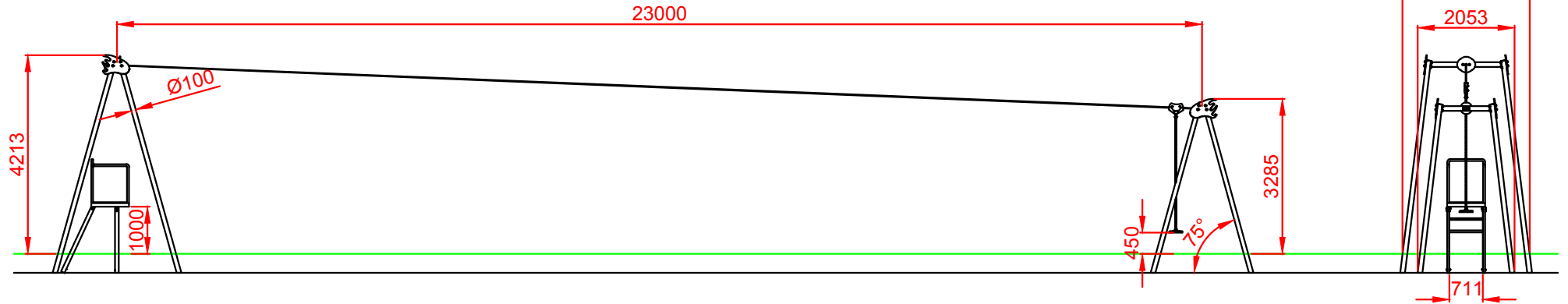

PERFIL

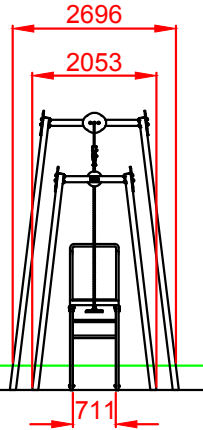

PLANTA

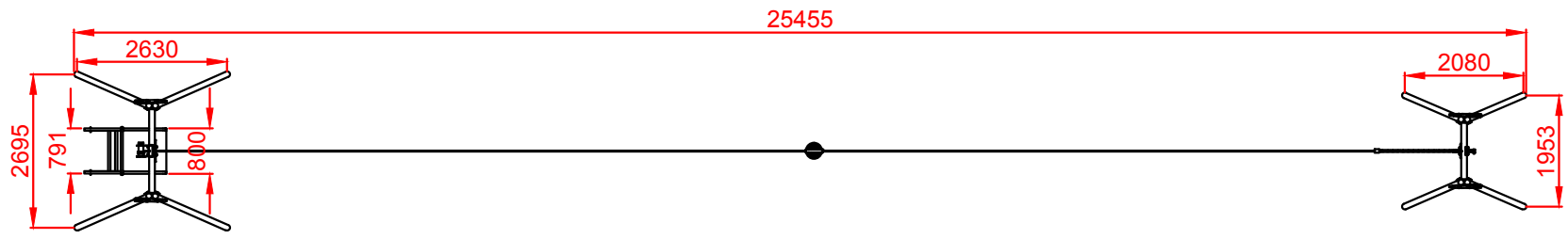

Dibujado		PLANO 3 DETALLES		Ref:	COM03
Revisado				Escala:	Nº Hoja 4/4
Aprobado					
Descripción:			TIROLINA (23 METROS)		

