

DOCUMENTACIÓN TÉCNICA



Ref.: COM07

Barco "Índico"

UNE EN 1176-1:2018
UNE EN 1176-3:2018



Altura libre de caída: 1,36 m
Edad recomendada de uso: a partir de 3 años
Madera de pino tratada en autoclave Nivel IV
Componentes plásticos: Polietileno de alta densidad con protección UV
Componentes metálicos galvanizados
Tobogán con rampa de acero inoxidable
Tubos de barrera de acero inoxidable

PERFIL DERECHO

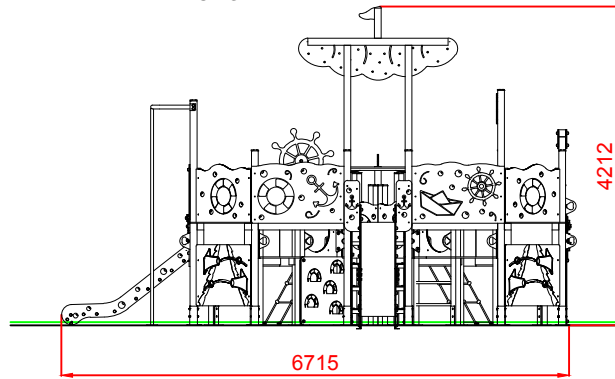

ALZADO

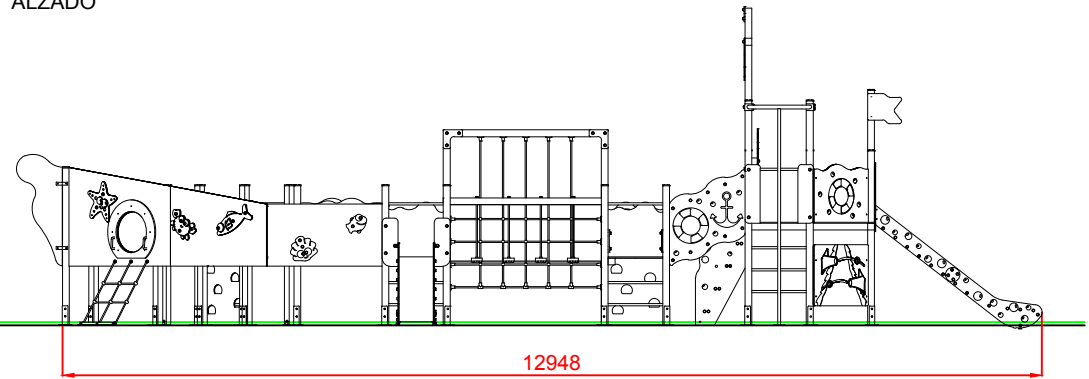

PLANTA

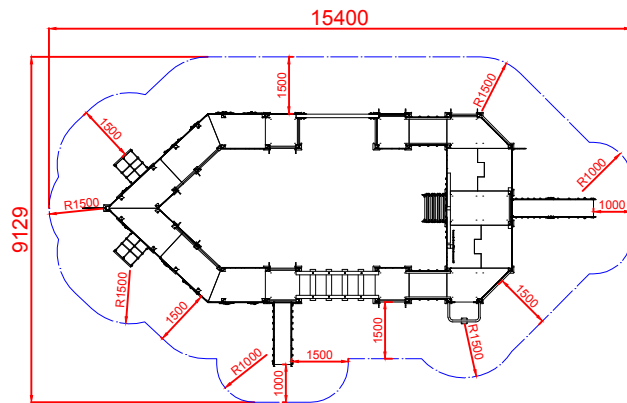

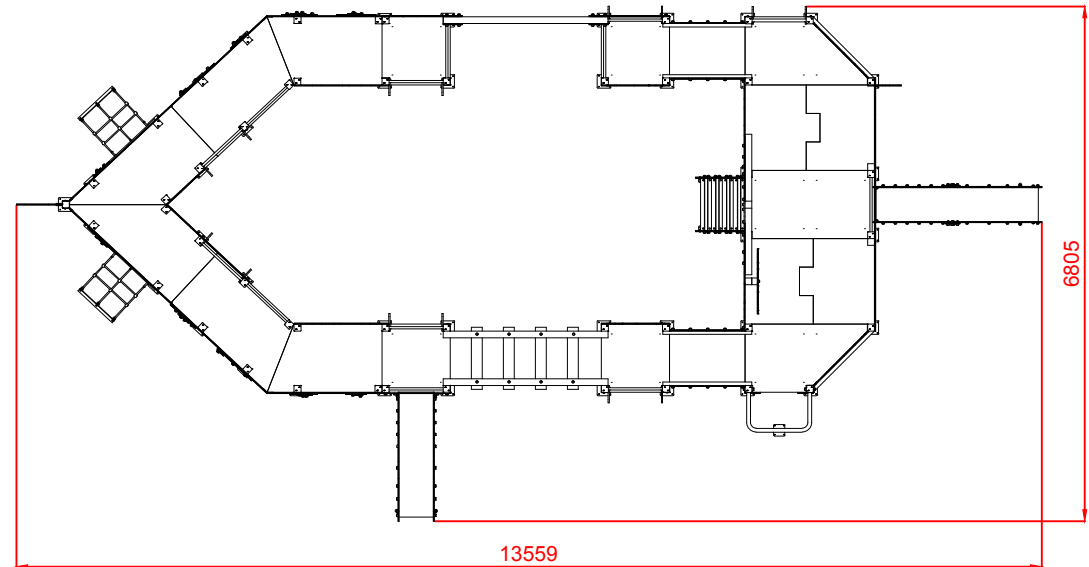

ÁREA DE SEGURIDAD
Superficie= 170,87 m²
E:1/2

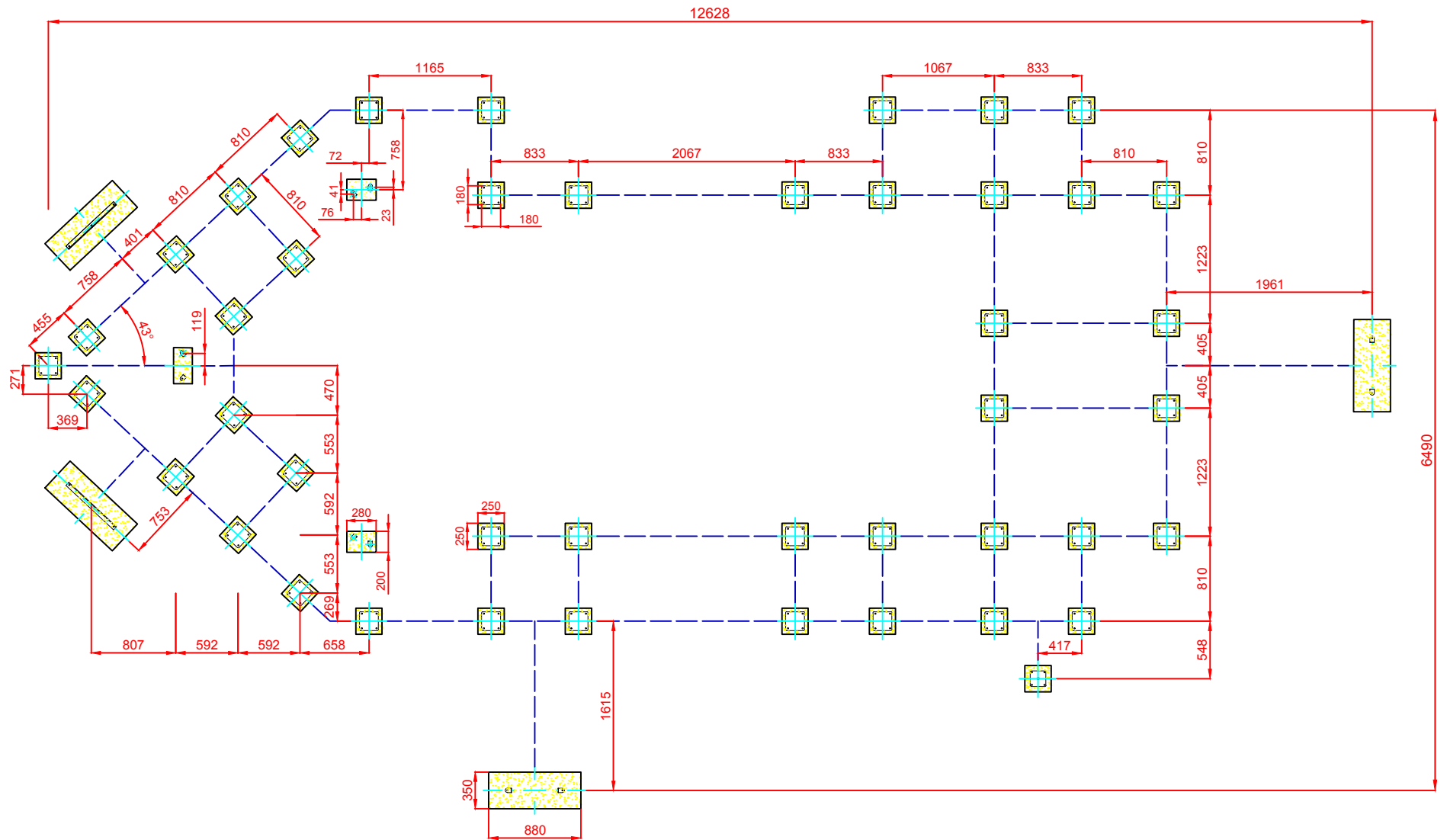

Dibujado		PLANO 1 VISTAS GENERALES		Ref: COM07
Revisado				
Aprobado				
Descripción:	BARCO "ÍNDICO"		Escala: N° Hoja 2/5 Fecha: 11/02/2020	

PLANTA CIMENTACIÓN



Dibujado		PLANO 2 PLANTA DE CIMENTACIÓN	Ref: COM07	
Revisado				
Aprobado				
Descripción:		Escala:	Nº Hoja	
BARCO "ÍNDICO"			3/5	
		Fecha:	11/02/2020	

DETALLES CIMENTACIÓN

ESQUEMAS DE CIMENTACIÓN EN ARENA

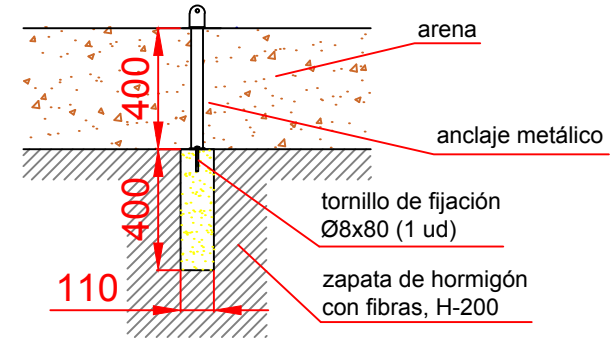
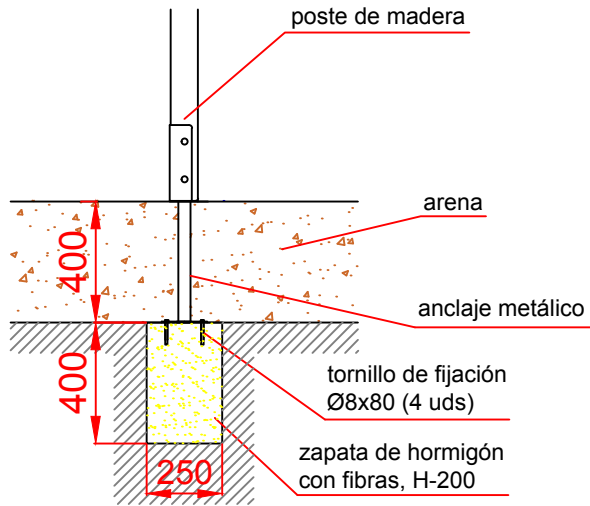

ESQUEMAS DE CIMENTACIÓN EN HORMIGÓN

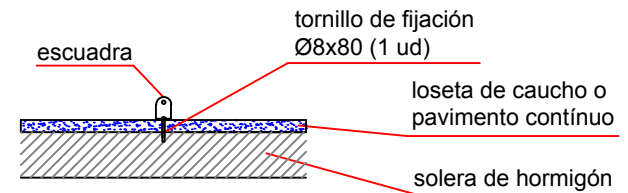
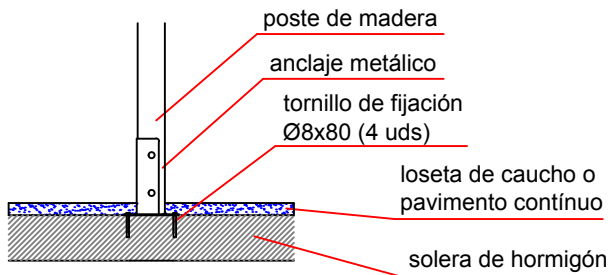

Dibujado		PLANO 3 DETALLES DE CIMENTACIÓN	Ref: COM07
Revisado			
Aprobado			
Descripción:	BARCO "ÍNDICO"		Escala: N° Hoja 4/5 Fecha: 11/02/2020



