

DOCUMENTACIÓN TÉCNICA



Ref.: EC11

Refuerzo 2000

EN-UNE 16630



Componentes de acero carbono
Tratamiento galvanizado y pintado al horno
Tornillería protegida con tapones de polipropileno

ALZADO

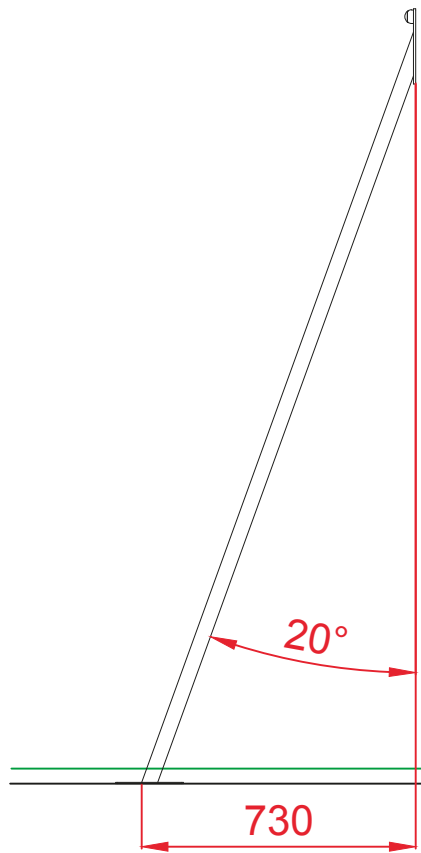

PERFIL

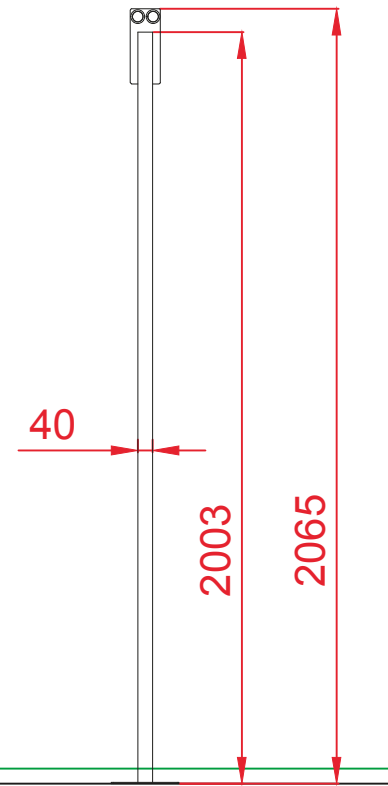

PLANTA

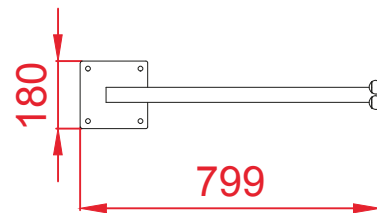

Dibujado		PLANO 1 VISTAS GENERALES		Ref:	EC11
Revisado					
Aprobado					
Descripción:			Escala:	Hoja:	
REFUERZO 2000				2/3	
			Fecha:	15/07/2019	



ESQUEMA DE CIMENTACIÓN EN ARENA

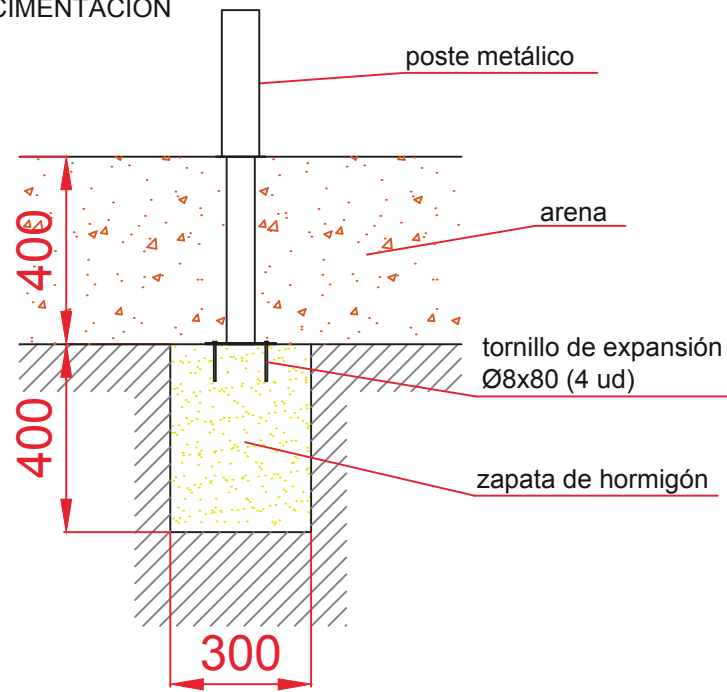

PLANTA

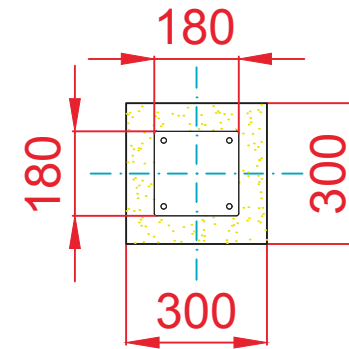

ESQUEMA DE CIMENTACIÓN EN HORMIGÓN

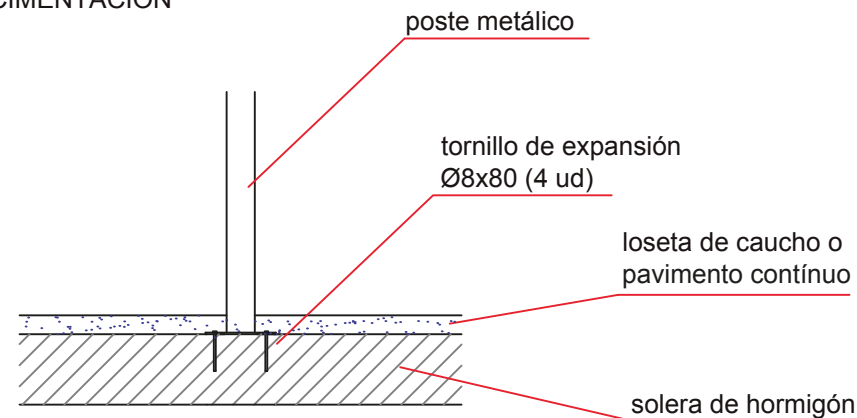

DETALLE DE ANCLAJE

Dibujado		PLANO 2 CIMENTACIÓN		Ref: EC11
Revisado				
Aprobado				
Descripción:		Escala:	Hoja:	
REFUERZO 2000			3/3	
		Fecha:	15/07/2019	

