

DOCUMENTACIÓN TÉCNICA



Ref.:GRO04

GEOROK 04

UNE EN 1176-1:2018

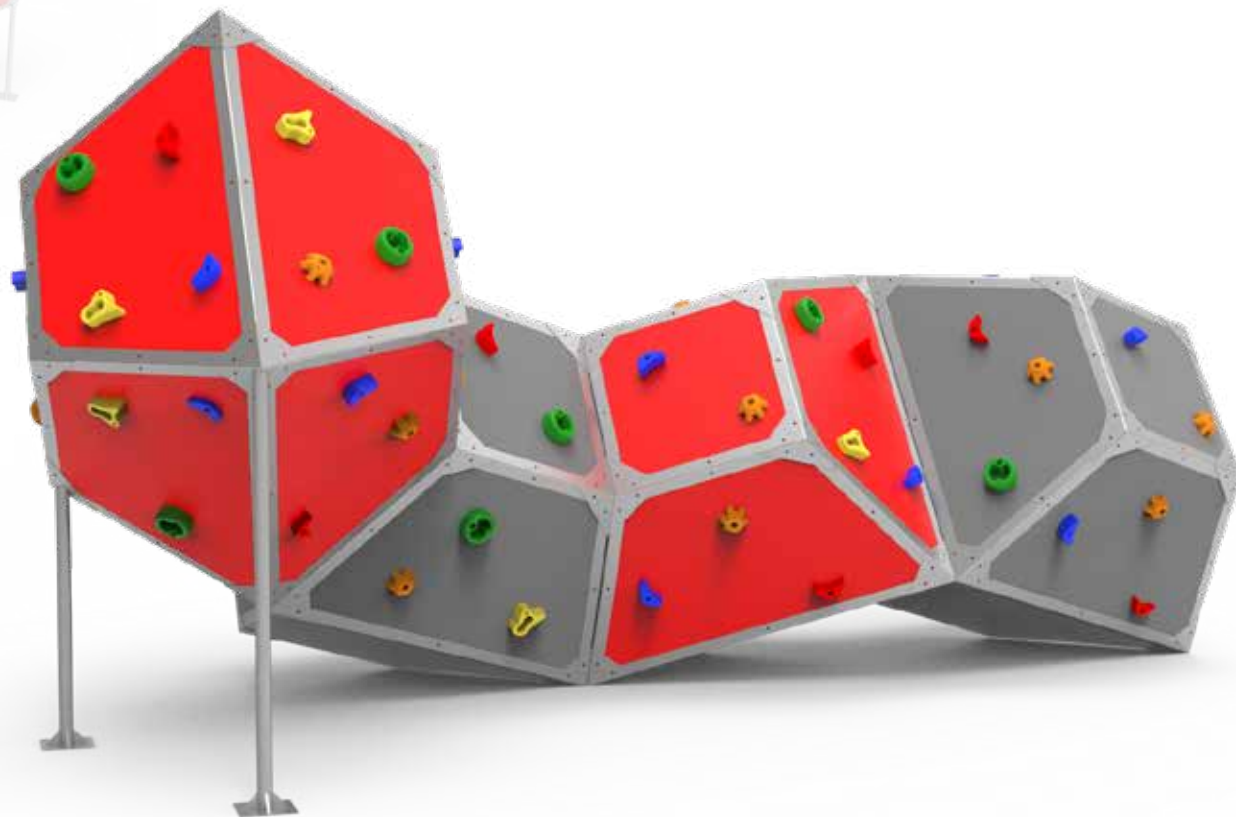

Altura libre de caída: 2,09 m
Edad recomendada de uso: de 3 a 14 años
Piedras escalada de poliresina de alta calidad
Perfil estructural metálico inoxidable
Tablero de polietileno de alta densidad con protección UV
Tornillería de acero inoxidable

ALZADO

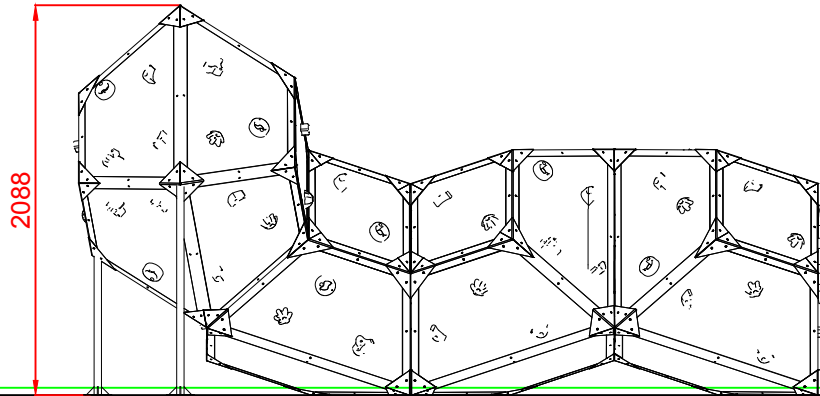

PERFIL

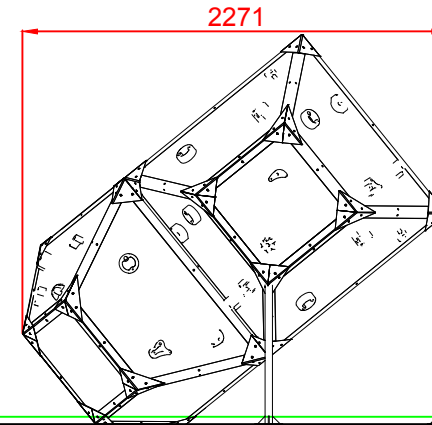

PLANTA

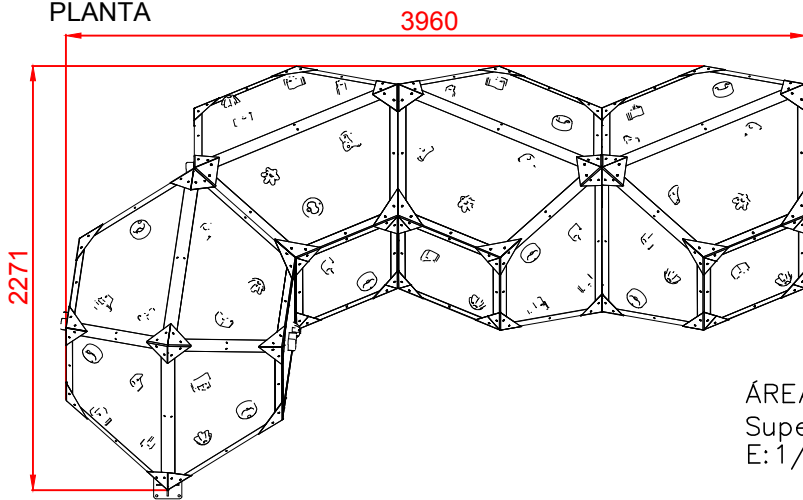

ÁREA DE SEGURIDAD
Superficie= 32,88 m²
E: 1/2

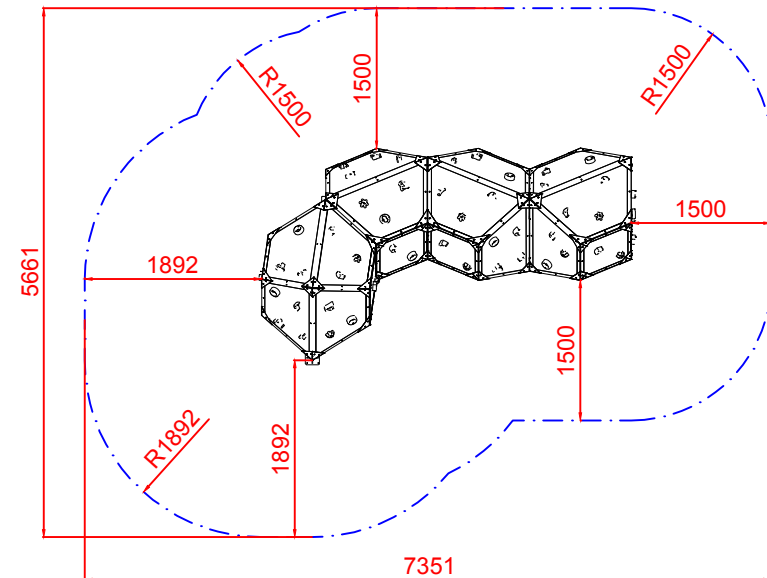

Dibujado		PLANO 1 VISTAS GENERALES		Ref:	GRO04
Revisado					
Aprobado					
Descripción:		Escala:	Nº Hoja		
" GEOROK 04 "		Fecha:	2/4 26/04/2021		

DETALLES CIMENTACIÓN

ESQUEMA DE CIMENTACIÓN EN ARENA

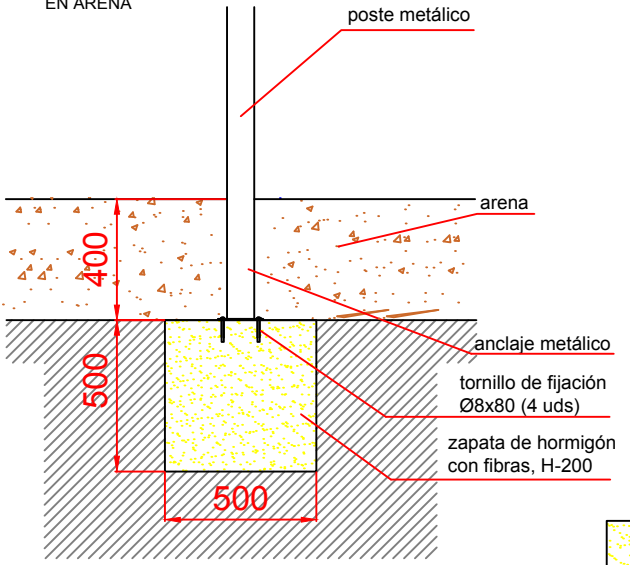

ESQUEMA DE CIMENTACIÓN EN HORMIGÓN

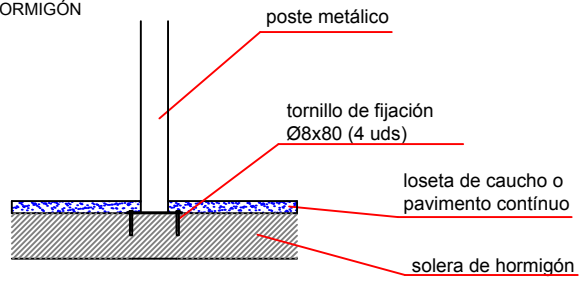

PLANTA CIMENTACIÓN

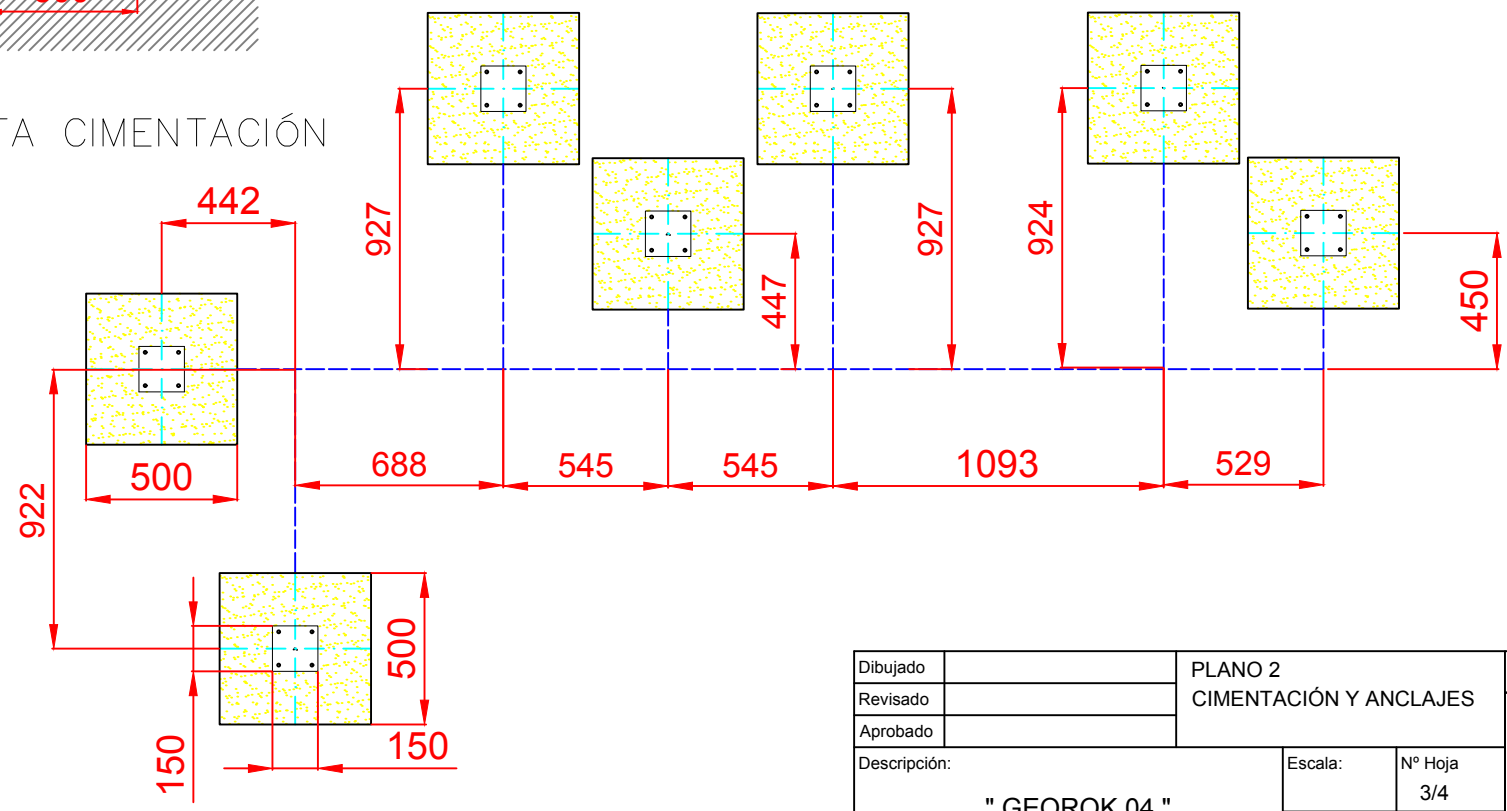

Dibujado		PLANO 2 CIMENTACIÓN Y ANCLAJES	Ref:	GRO04
Revisado				
Aprobado				
Descripción:		" GEOROK 04 "	Escala:	Nº Hoja 3/4
			Fecha:	26/04/2021

ALZADO

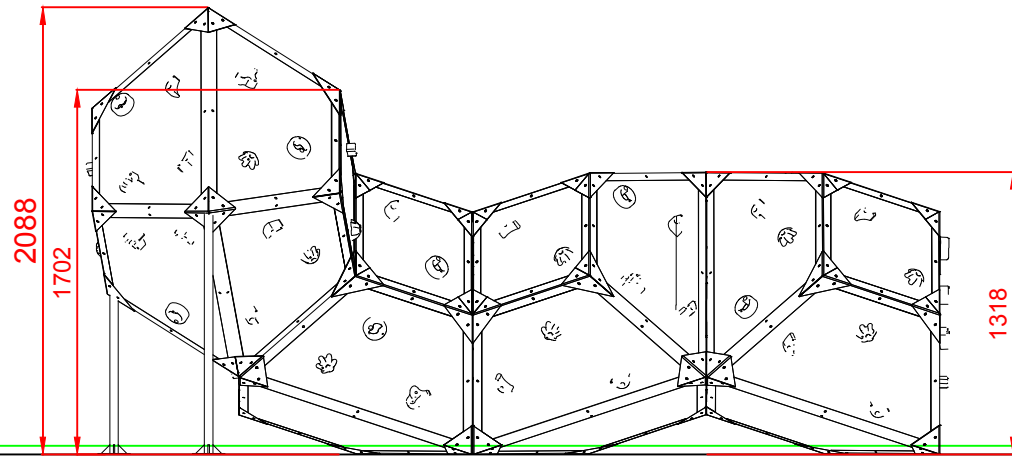

PERFIL

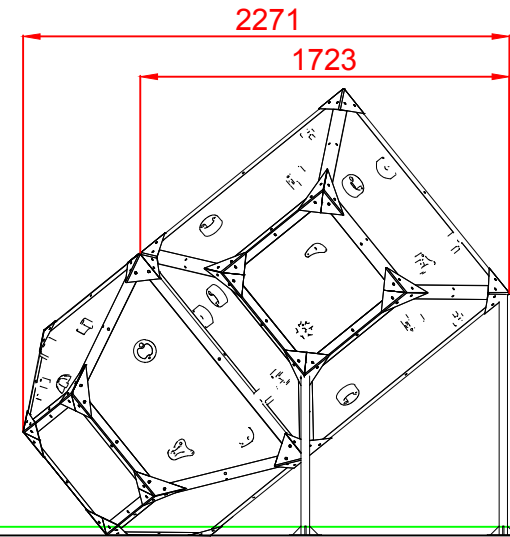

PLANTA

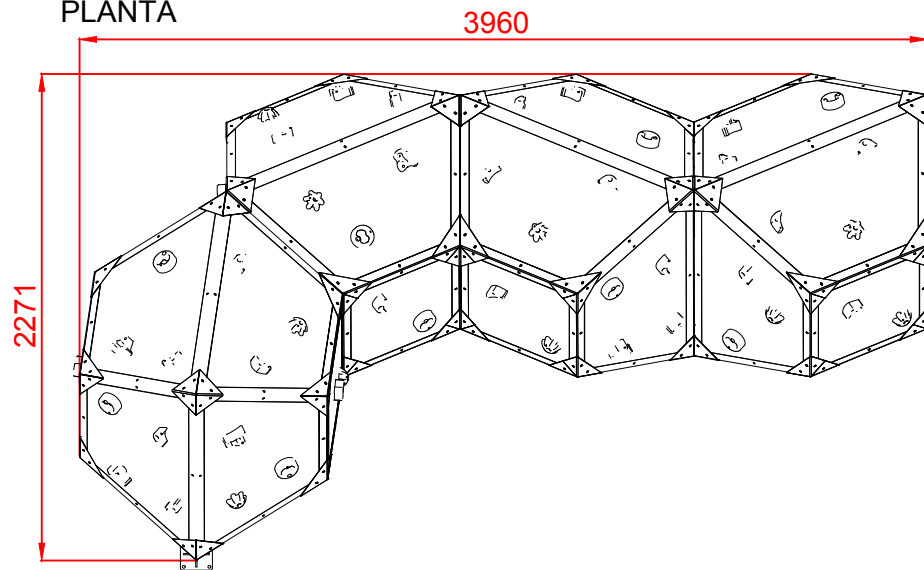

Dibujado		PLANO 3 VISTAS DE DETALLE		Ref:	GRO04
Revisado					
Aprobado					
Descripción:		Escala:	Nº Hoja		
" GEOROK 04 "			4/4		
		Fecha:	26/04/2021		