

DOCUMENTACIÓN TÉCNICA



Ref.: MC07

Barra 900

EN-UNE 16630



Edad recomendada jóvenes y adultos
que midan más de 1,40 m de estatura

Altura libre de caída 0,90 m

Componentes de acero carbono

Tratamiento galvanizado y pintado al horno

Tornillería protegida con tapones de polipropileno

1 usuario

ALZADO

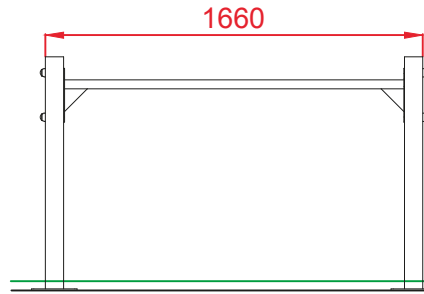

PERFIL

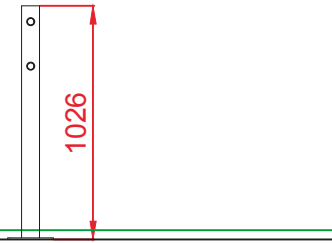

PLANTA

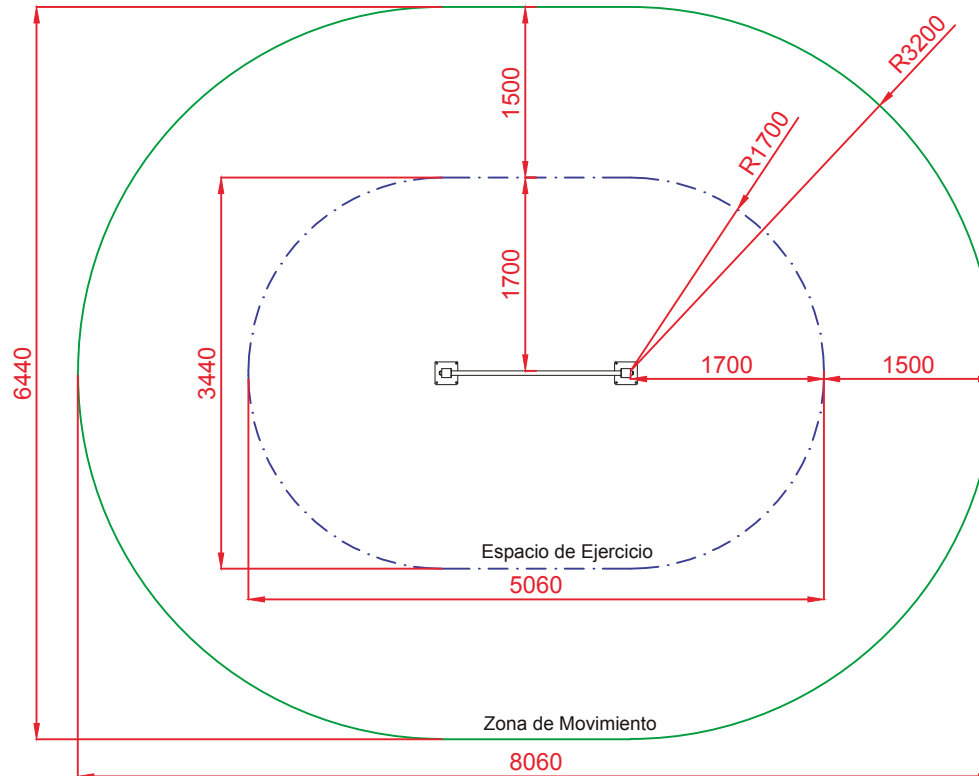
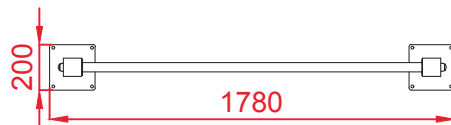

Área Movimiento: 43,12 m²
 Área Ejercicio: 14,93 m²
 Escala 1:2

Dibujado		PLANO 1		Ref:	MC07
Revisado		VISTAS GENERALES			
Aprobado					
Descripción:		Escala:	Hoja:		
BARRA 900			2/5		
		Fecha:		10/07/2019	

DETALLES CIMENTACIÓN

ESQUEMA DE CIMENTACIÓN EN ARENA

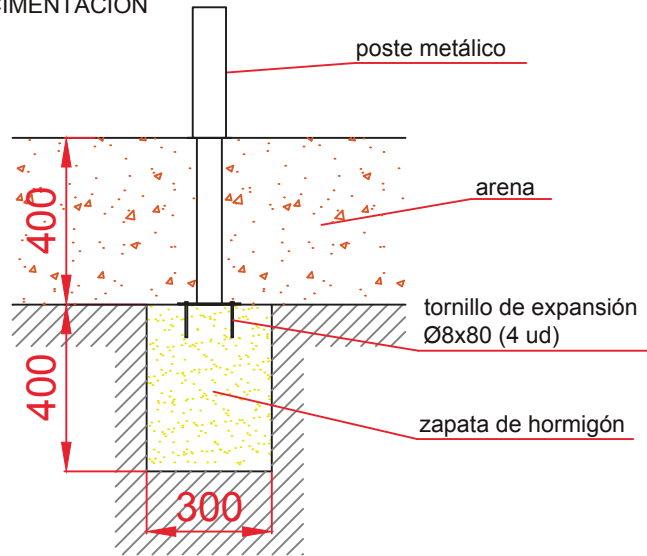

ESQUEMA DE CIMENTACIÓN EN HORMIGÓN

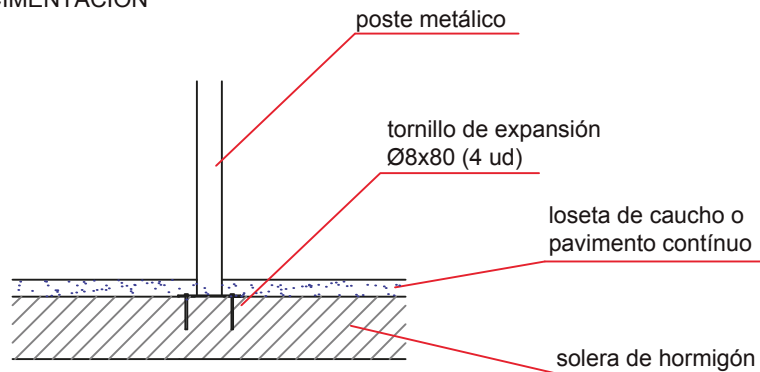

DETALLE DE ANCLAJE

PLANTA



Dibujado		PLANO 2 CIMENTACIÓN		Ref: MC07
Revisado				
Aprobado				
Descripción: BARRAS 900		Escala:	Hoja: 3/5	
		Fecha: 10/07/2019		

ALZADO

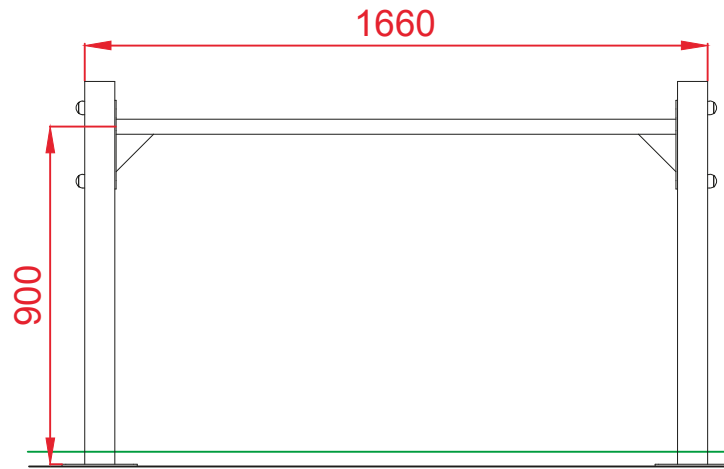

PERFIL

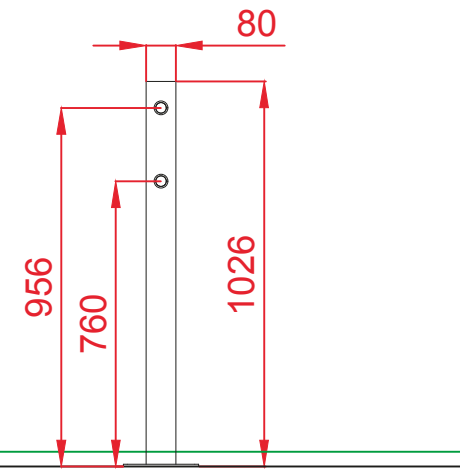

PLANTA

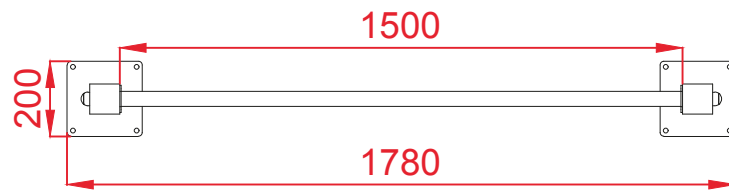

Dibujado		PLANO 3		Ref:	MC07
Revisado		VISTAS DE DETALLE			
Aprobado					
Descripción:			Escala:	Hoja:	
BARRAS 900				4/5	
			Fecha:	10/07/2019	



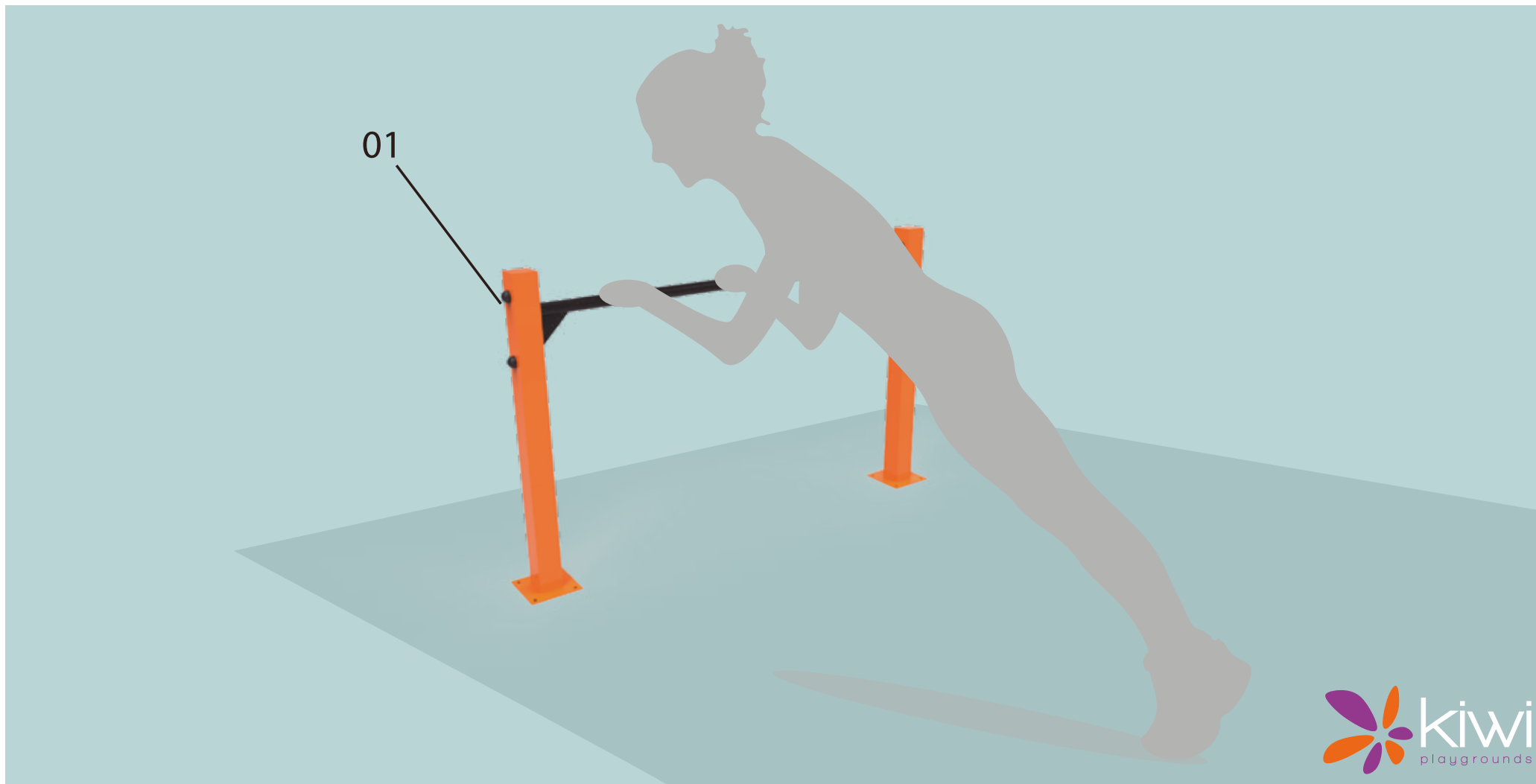

BARRA SIMPLE

01



FUNCIÓN: Ejercicios para fortalecer los músculos de los brazos y pecho, principalmente.

USO: Con los brazos estirados, y las manos agarrando la barra a la altura del pecho, elevar el tronco, manteniendo los pies en el suelo. Flexionar los codos hasta que el pecho toque la barra o los codos alcancen la flexión de 90°.