

DOCUMENTACIÓN TÉCNICA



Ref.: MXT28

Maxi Torre "Isla Grosa"

UNE EN 1176-1:2018

UNE EN 1176-2:2018

UNE EN 1176-3:2018



Altura libre de caída: 1,65 m

Edad recomendada de uso: a partir de 3 años

Madera de pino tratada en autoclave Nivel IV

Componentes plásticos: Polietileno de alta densidad con protección UV

Componentes metálicos galvanizados

Tobogán con rampa de acero inoxidable

Tubos de barrera de acero inoxidable

ALZADO

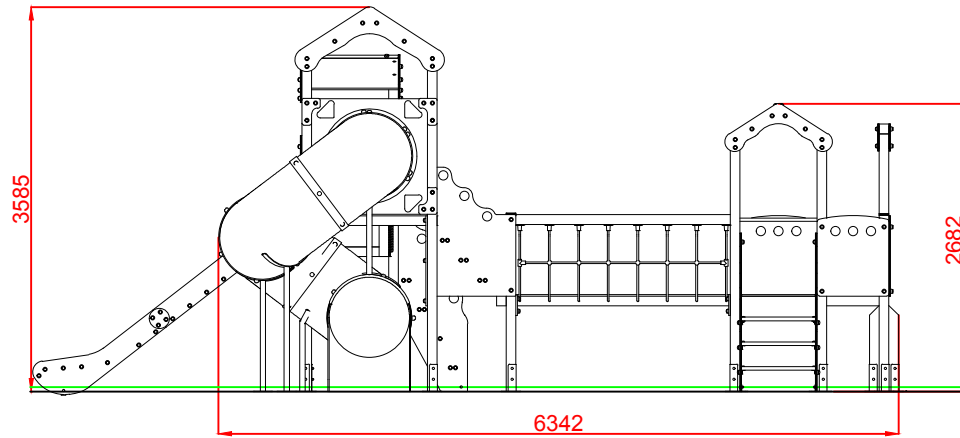

PERFIL DERECHO

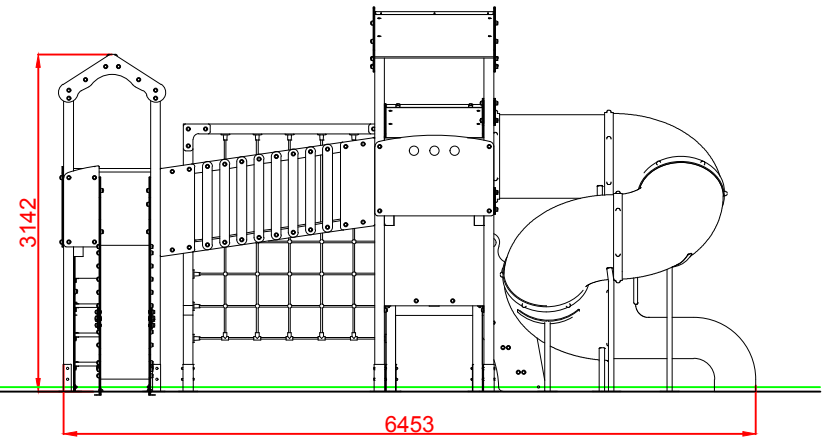

PLANTA

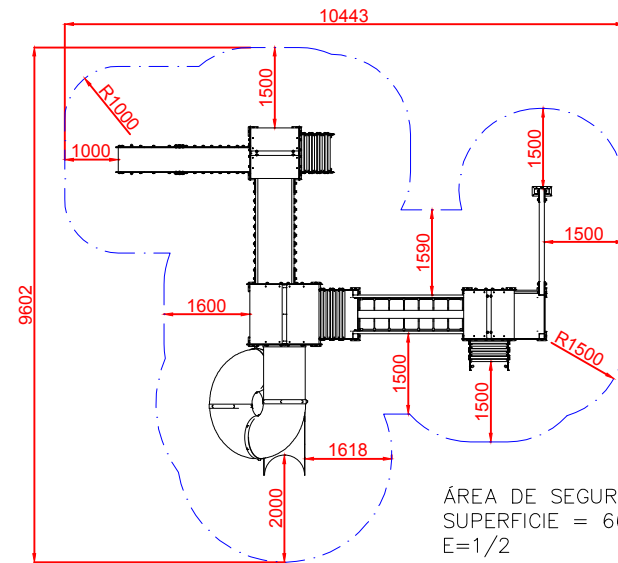
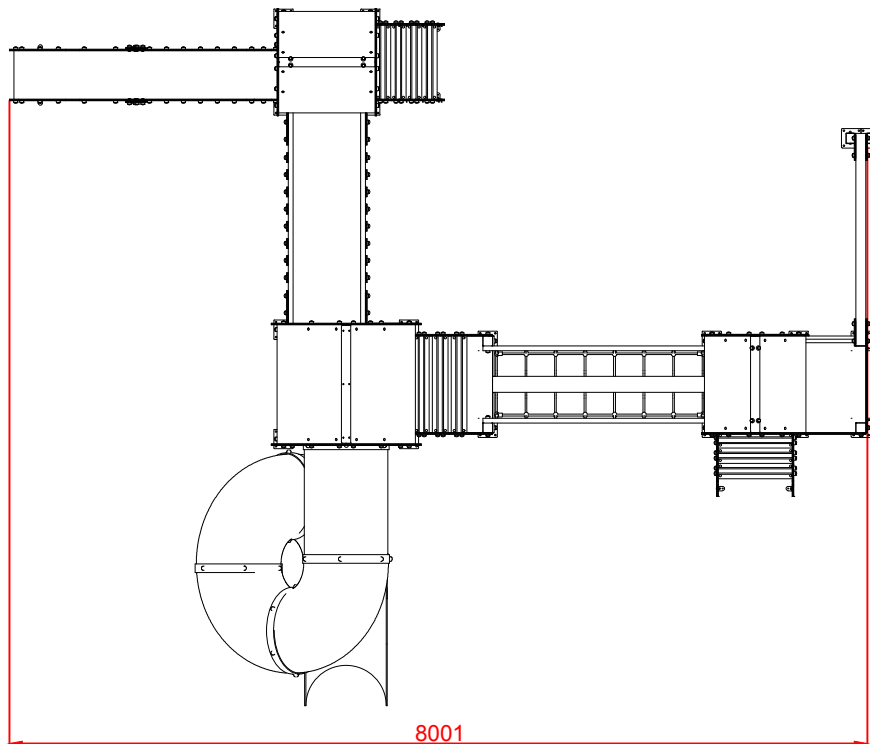

ÁREA DE SEGURIDAD
SUPERFICIE = 66,91 m²
E=1/2

Dibujado		PLANO 1 VISTAS GENERALES		Ref: MXT28
Revisado				
Aprobado				
Descripción: MAXI TORRE "ISLA GROSA"		Escala:	Nº Hoja 2/4	
		Fecha:	22/04/2020	

PLANTA CIMENTACIÓN

DETALLES CIMENTACIÓN

ESQUEMA DE CIMENTACIÓN EN ARENA

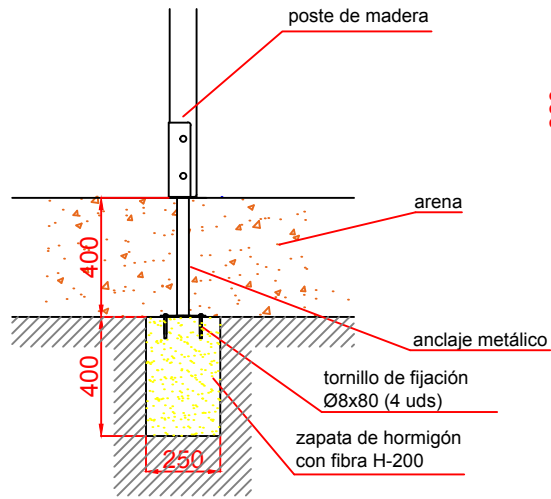

ESQUEMA DE CIMENTACIÓN EN HORMIGÓN

E: 2/1

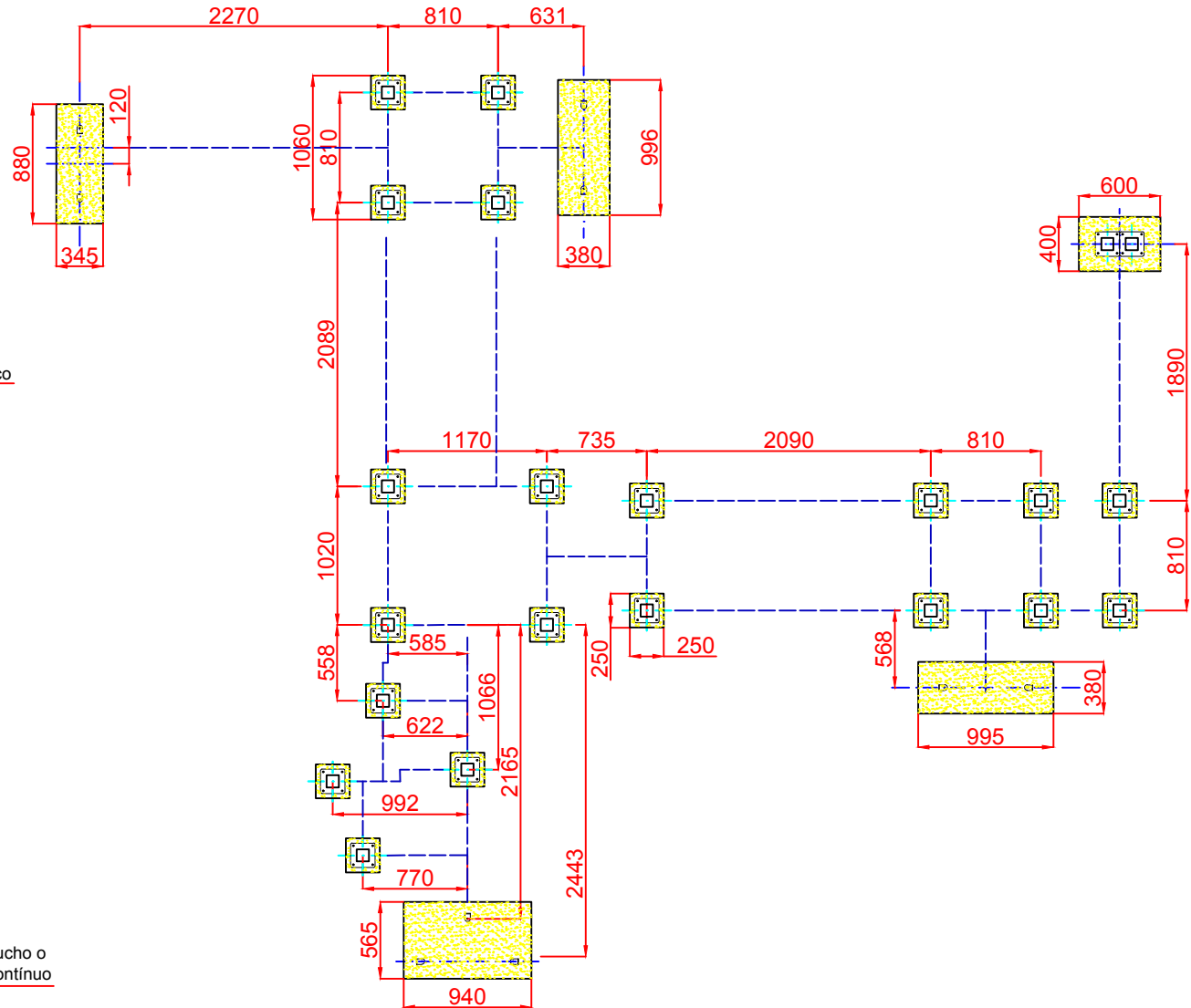
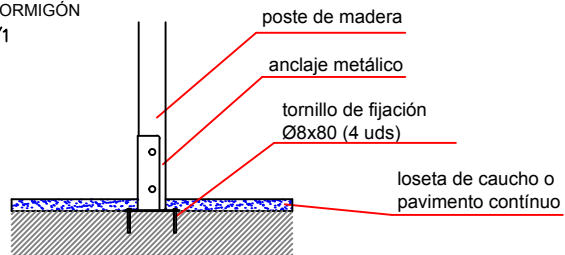

Dibujado		PLANO 2		Ref: MXT28
Revisado		CIMENTACIÓN Y ANCLAJES		
Aprobado		Descripción:	Escala:	Nº Hoja
		MAXI TORRE "ISLA GROSA"		3/4
			Fecha:	22/04/2020



ALZADO

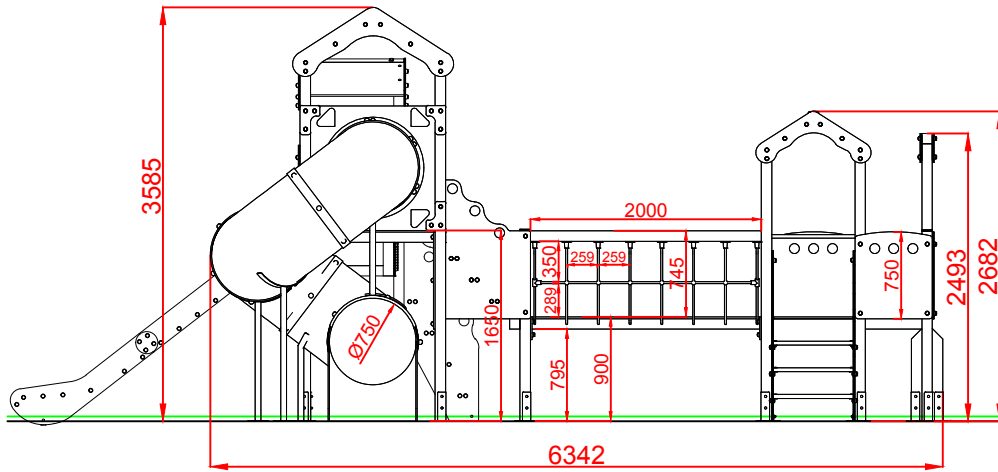

PERFIL DERECHO

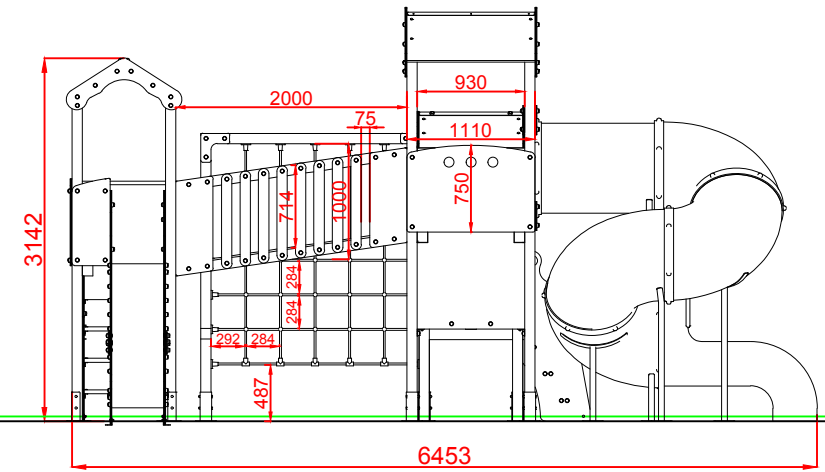

PLANTA

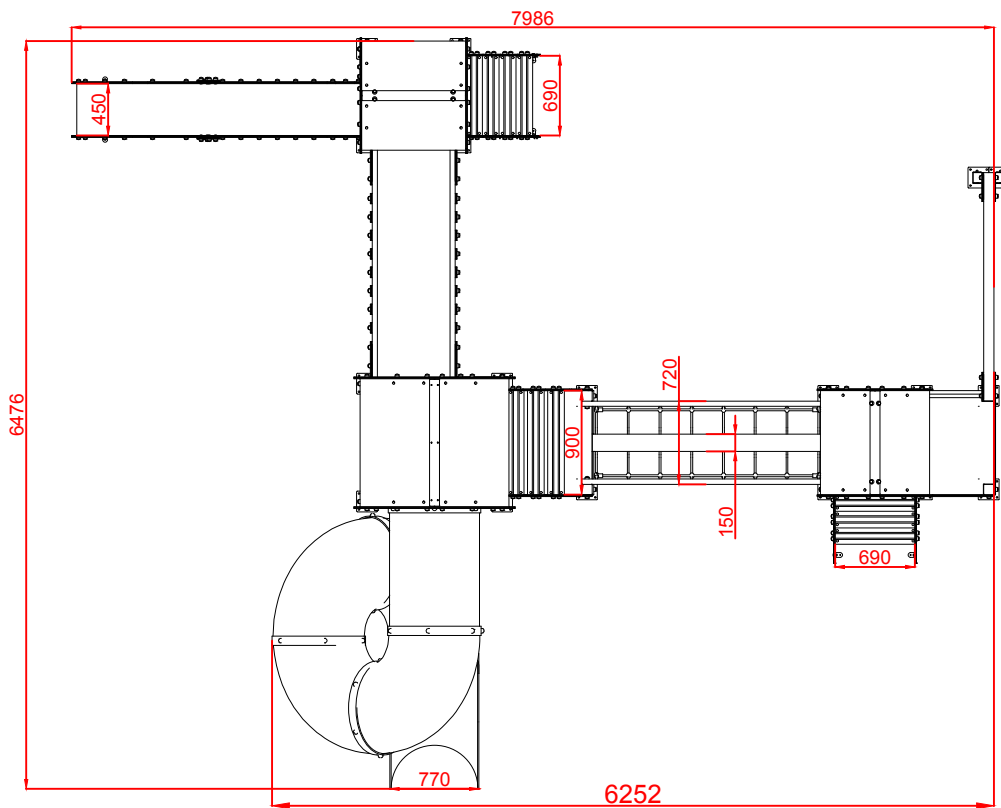

Dibujado		PLANO 3 VISTAS DE DETALLE		Ref: MXT28
Revisado				
Aprobado				
Descripción:		MAXI TORRE "ISLA GROSA"	Escala:	Nº Hoja 4/4
			Fecha:	22/04/2020